



EMHKAM

PUMPS

GEAR PUMP FX series

INSTRUCTIONS FOR INSTALLATION, OPERATION & MAINTENANCE

VERSION: 2.1 DATE: 30/03/2022



**WARNING! READ THE
INSTRUCTIONS MANUAL
BEFORE OPERATE**



MARKIDIS P. & Co G.P.

Sindos Industrial Area, Block 39 A, P.C. 570 22, Thessaloniki, Greece

Tel: (+302310) 79 78 33, Fax: (+302310) 79 79 65

e-mail: contact@emikam.com , web: www.emikam.gr

INDEX

1. MARKING	3
1.1 Technical characteristics label.....	3
1.1 Installation.....	3
2. LABELS USED	4
3. INTRODUCTION TO THE MANUAL	6
4. SAFETY MEASURES	7
4.1 Specifications.....	7
4.2 Safety data.....	7
5. INTENDED USE	8
5.1 Application field.....	8
6. PERFORMANCE	9
7. INSTALLATION	10
7.1 Flushing the pump	11
7.2 Piping installation	11
7.3 Pump station installation.....	11
7.4 Pump mounting.....	12
7.5 Pump rotation layout.....	12
7.6 Pump rotation.....	13
8. OPERATION	14
8.1 Pre – start check list:.....	14
8.2 Rotation start.....	14
8.3 Reverse rotation.....	15
8.4 Flushing the pump	15
8.5 Relief valve	15
9. MAINTENANCE - CLEANING	17
9.1 Bearing lubrication	18
9.2 Pipe fitting lubrication.....	18
9.3 Cleaning after use.....	19
9.4 Cleaning of the relief valve (bypass).....	19
9.5 Strainers.....	19
9.6 Gear replacement	20
9.7 Gear – lip seal replacement.....	20
9.8 Replacement of gear - lip seals - bearings	20
9.9 Replacement of gears.....	21
9.10 Replacement of seal	21
9.11 Replacement of bearings.....	21
9.12 Replacement of gears.....	21
9.13 Replacement of seal	22
10. TRANSPORT / STORAGE	23
11. TROUBLESHOOTING	24

1. MARKING

1.1 Technical characteristics label

A label as the one shown below is placed on each pump.

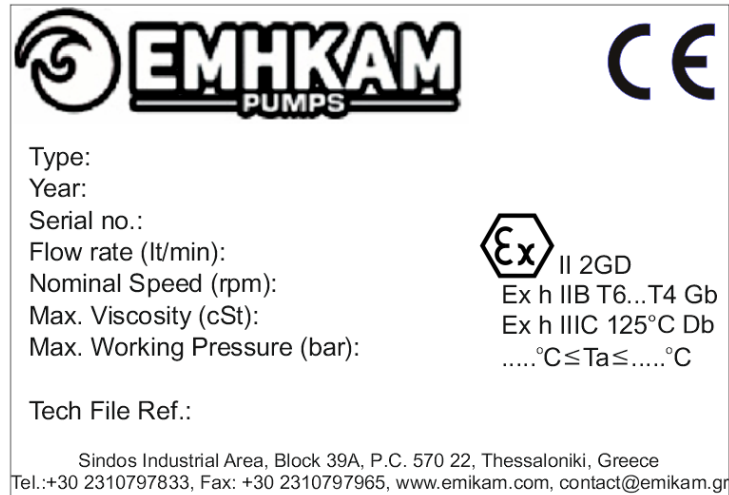

Picture 1: Technical characteristics label

1.1 Installation

Stamp and signature for both manufacturer and installer are filled below.

FOR THE MANUFACTURER

INSTALLER

Date:

Date:



Information included in each label (**identification with serial number**) has to be familiar in order for the reference on them to be easy when they get asked. This can happen in case of spare parts ordering from the manufacturing company where identification of the pump is necessary through label data.

2. LABELS USED



This is a safety alert symbol. When you see this symbol on the product or in the manual, look for one of the following signal words and be alert for potential personal injury, death or major property damage.



This symbol follows message relative to information that are reported in the present manual or in the accompanying handbook and should be taken under consideration.



This symbol follows indication.

The symbols below describe possible accidents or important points regarding the operation of the machine. The messages that follow inform about the associated risks.



Always disconnect the electrical power supply before performing any maintenance, in order to avoid risks of electric shock, fire or even death.



If pumping hazardous or toxic fluids, the system must be flushed prior to performing service.



Operation without guards in place can cause serious personal injury, major property damage, or death.



Disconnecting fluid or pressure containment components during pump operation can cause serious personal injury, death or major property damage.



Failure to relief system pressure prior to performing pump service or maintenance can cause personal injury or property damage.



Failure to disconnect electrical power or engine drive before attempting maintenance can cause severe personal injury or death.



High temperature in the pump can cause ignition in gases and dust.



In hazardous areas smoking and existence of naked flame are prohibited.



Use proper equipment for explosive atmosphere.



Contact with hot surfaces can cause serious burn.



Grease oil and lubricants can pollute the environment.



Follow the instructions of the manual in order to avoid risks of severe personal injury or death.

3. INTRODUCTION TO THE MANUAL

We strongly recommend to read this manual carefully before proceeding with the installation, operation and maintenance of the pump.

This manual refers to «**EMHKAM**» **gear pumps** and aims on helping for the best processing of all the above.

«**EMHKAM**» company does not have any responsibility for damages resulting from improper use or actions not complying with the instructions included in this manual.



ATTENTION! This manual is an integral part of **EMHKAM gear pumps** and should accompany it in every transfer or resale. It should be kept in a safe place, and personnel must be aware of it. Personnel are also responsible for the good condition and safekeeping of the manual. In case of damage or loss, you must request a new copy from the manufacturer.



Never neglect to review this manual, independently from your previous experience. Few moments of study will save you time, money and most important avoid difficult situations.



Service shall be performed by qualified technicians **ONLY**. Service shall conform to all applicable local and national regulations and safety standards.

4. SAFETY MEASURES

4.1 Specifications

Sliding Vane pumps have been manufactured and assembled according to the regulations of Directive **2006/42/EC** for machine safety and **2014/34/EU** for equipment used in explosive atmosphere.



Gear pumps are classified as non-electrical equipment intended for use in explosive atmosphere.

4.2 Safety data



ATTENTION! Non-conformance with the following can cause personal injury, death or major property damage.

- EMHKAM pumps **MUST** only be installed in systems which have been designed by qualified engineering personnel. The system **MUST** conform to all applicable local and national regulations and safety standards.
- Pump installation, operation and maintenance shall be performed by qualified technicians **ONLY**. Service shall conform to all applicable local and national regulations and safety measures.
 - Never proceed on changes on the pump in any circumstances.
 - Use only original spare parts or parts approved by the manufacturer.
 - **Never operate the pump without liquid** except from specific cases mentioned in the manual.

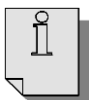



At certain installations and operation points on the pump curve the noise level of 70dB can be exceeded.

5. INTENDED USE

5.1 Application field

Gear pumps of cast iron metal with rotary lip seals for low pressure medium duty applications of low and medium viscosity clean liquids such as Lubricants, Fuel Oils, Diesel, Bio-Diesel etc.

 **ATTENTION!** Use only proper liquid in order to avoid damage or even corrosion of the sealing and possible leakage.

 **ATTENTION!** Pumps are the kind of equipment where surface temperature depends on the liquid temperature used. Overheating of the product can cause inappropriate operation and surface temperatures on the pump.

 Operator of the pump should secure the safe temperature limits and never allow the temperature to exceed them.

6. PERFORMANCE

Pump model	Minimum Pump Speed			Maximum Pump Speed			Maximum differential pressure	Maximum working pressure	Maximum operating temperature
	Speed	Flow	Viscosity	Speed	Flow	Viscosity			
	Rpm	lpm (gpm)	cSt (ssu)	Rpm	lpm (gpm)	cSt (ssu)			
							bar (psi)	bar (psi)	°C (°F)
FX1	150	15 (4)	440.000 (2.000.000)	900	60 (16)	6 (46)	9 (130)	10 (145)	200 (392)
FX1.25	150	15 (4)	440.000 (2.000.000)	900	60 (16)	6 (46)	9 (130)	10 (145)	200 (392)
FX1.5	150	30 (8)	440.000 (2.000.000)	800	225 (60)	6 (46)	9 (130)	10 (145)	200 (392)
FX3	150	100 (26,5)	440.000 (2.000.000)	800	800 (211)	6 (46)	9 (130)	10 (145)	200 (392)
FX4	150	150 (40)	440.000 (2.000.000)	800	1050 (277)	6 (46)	9 (130)	10 (145)	200 (392)

Table 1: Performance data

7. INSTALLATION



EMHKAM pumps must only be installed in systems designed by qualified engineering personnel. System design must conform to all applicable regulations and codes and provide warning of all system hazards.



**DANGER!
ELECTRIC
SHOCK**

Always disconnect the electrical power supply before performing any maintenance, in order to avoid risks of electric shock, fire or even death. (Only in case the pump is rotated through electromotor or is part of a pump station).



ATTENTION! Installation has to be done after making sure you have unplugged and secured the electrical power supply in case of electromotive pump.



ATTENTION! Electrical power supply has to comply to the technical data label of the electric motor.



ATTENTION! During the electrical installation, follow all the security rules. Ground the electrical circuit in all cases.

EMHKAM gear pumps can be installed on tank truck's PTO (power take off) with Cardan shaft and be power supplied by electromotor, by hydraulic motor, by ICE (internal combustion engines) or be installed on EMHKAM pump station-metering system.



FX series pumps can be equipped with a hydraulic motor adaptor. The recommended size of the motor for 1.5" pumps is 50cc and for 3", 4" pumps 80cc. Optionally any size of hydraulic motor can be installed.

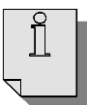

For more information concerning installation and operation of the EMHKAM pump stations, refer to the respective instructions manuals.

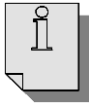

Upon request FX series pumps can be equipped with a socket for connection of a PT100 temperature sensor.

7.1 Flushing the pump



Make sure you clean the pump with plenty of water before first use. It contains anti-rusting liquid.



ATTENTION! When installing on tank trucks make sure that no welding residue enter the pump's chamber. Entering of welding residues into the pump chamber may cause severe damage or breakdown of the pump.

7.2 Piping installation

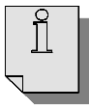

Inlet circuit of the pump has to be free of materials other than those which are meant to be pumped. Such an existence may cause severe damage or breakdown of the pump.

Before pipe installation beware of the following:

- Place pump's inlet as closer possible to the liquid supply to avoid frictions loses.
- Install a strainer on the inlet pipe to protect the pump from solids entering. The strainer has to be placed very close to the pump and has to cover surface four times equal to the pump inlet.

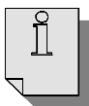

Consult technical data of the manufacturer for each pump concerning its maintenance.

- No air should enter the piping.
- Piping parts have to be designed for at least equal pressure level to the pump.
- Piping has to be aligned.

7.3 Pump station installation

All the above apply also to a pump station installation as well as a connection of the plug of the electrical panel for power supply.



ATTENTION! When connecting the pump to the electric power, make sure for ground existence and compatibility of connector – socket.

7.4 Pump mounting

a) In case of installing on a **tank truck**, the pump can be bolted to the truck frame or on a construction fitted on the truck.

b) Base of the pump has to be steady and fastened to anchors when it's about **permanent installations** in order to avoid vibrations.

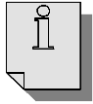

Pump can operate securely in every position settled.

7.5 Pump rotation layout

a) When pump is installed on a PTO (power take-off) with a Cardan shaft, the following should apply:

- The maximum angle between the PTO shaft and the pump shaft is 15° degrees.
- The pump shaft and the PTO shaft must be parallel in all respects.
- The Cardan shaft length has to be regulated correctly.
- The safe guards to be in place.
- Cardan joints to be well fixed.

It is very important to apply a proper installation to avoid excessive damage, noise and vibrations.

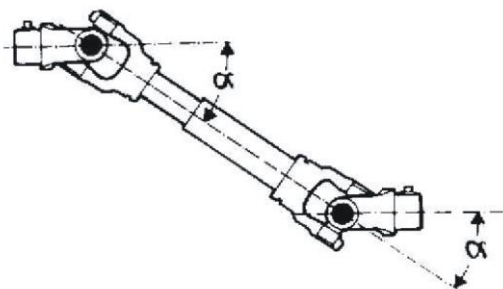

Picture 2: Cardan shaft

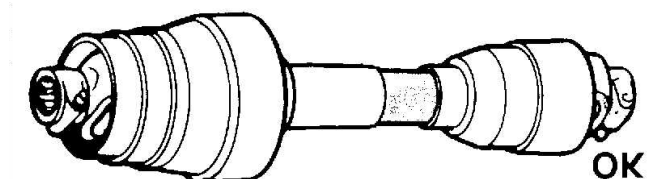

Picture 3: Safeguards install

b) When pump is moved by an electromotor, hydraulic motor or a pump station it uses:

- A coupling is fixed on the pump shaft and the motor with a shaft key.

For the **coupling alignment** you should:

Check the parallelism of the two shafts (motor – pump) after connection.



Use an alignment device to ensure that PTO and pump shaft are parallel to each other.

7.6 Pump rotation

Clockwise (CW) rotating pumps rotate as with a clock while counterclockwise (CCW) pumps rotate in reverse. Double end shaft pumps can rotate in both directions.



Confirm correct pump rotation by checking the pump rotation arrow.

To change rotation, the pump must be disassembled then reassembled with the shaft on the opposite side of the pump (see the maintenance section for instructions).

8. OPERATION



DANGER!
DO NOT REMOVE
SAFETY DEVICES

Operation without guards in place can cause serious personal injury, major property damage, or death.



FORBIDDEN
CLEANING AND
MAINTAIN DURING
OPERATION

Disconnecting fluid or pressure containment components during pump operation can cause serious personal injury, death or major property damage.



FORBIDDEN
CLEANING AND
MAINTAIN DURING
OPERATION

Failure to relief system pressure prior to performing pump service or maintenance can cause personal injury or property damage.

8.1 Pre – start check list:

Before operation perform the following checks:

1. Check the alignment of the pipes to the pump.
2. Check the alignment of the coupling and of the PTO – pump shafts. Check also the angle between the PTO shaft and the pump shaft to be 15 degrees.
3. Ensure that inlet and outlet of the pump are free of closed valves or other parts.
4. In a pump station, secure against movement.
5. Check safeguards installation to the connecting shaft of PTO – pump.
6. In a pump station check safeguard installation to the coupling.
7. Check motor connection and make sure that pump rotation is as indicated by the arrow on it.

8.2 Rotation start

For starting follow the procedure below:

1. Operate the driving set out to the pump (power take off or electromotor)
2. Check for leaks.
3. Inspect piping, fittings and associated system equipment for leaks, noise, vibration and overheating.

4. Check the pressure setting of the bypass valve by closing the exit of the pump. To increase the pressure setting, loosen the locknut and turn the adjusting screw inward or clockwise. Retighten the locknut. To decrease the pressure setting, loosen the locknut and turn the adjusting screw outward or counterclockwise. Retighten the locknut.



ATTENTION! DO NOT operate the pump against a closed outlet for a long period.



If adjustments need to be made, refer to the “bypass valve setting” section of this manual.



ATTENTION! Wrong adjustment of the bypass valve can cause serious injury, damage or death.

8.3 Reverse rotation

Pump must not operate for more than 1 minute in reverse and only with the existence of the bypass valve for protection against overheating.



ATTENTION! Reverse operation is allowed only for maintenance.

8.4 Flushing the pump

If flushing fluid has to be left in the pump for an extended time, it must be a lubricating, non –corrosive fluid. If a corrosive, non – lubricating fluid is used, it must be flushed from the pump immediately.

1. To clean the pump, leave the outlet open and the inlet closed.
2. Run cleaning fluid and operate for 1 minute.
3. To remove fluid follow step 1.

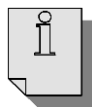

After flushing the pump some residual fluid may remain in the pump and piping.



Properly dispose of all waste fluids in accordance with the appropriate codes and regulations and don't infect the environment.

8.5 Relief valve

The bypass valve is designed to protect the pump from excessive pressure. Bypass valve is set by the manufacturer lower than the maximum operation pressure.

To regulate the relief valve follow the next steps:

1. Bypass valve carries for its regulation a screw and a locknut.
2. To increase the pressure setting we loosen the locknut.
3. Then we turn the adjusting screw clockwise until the desiring point.
4. We retighten the locknut to secure the screw.
5. We follow the same procedure in case we want to decrease the pressure setting but by turning the screw counterclockwise.

9. MAINTENANCE - CLEANING



**DANGER!
ELECTRIC
SHOCK**

Always disconnect the electrical power supply before performing any maintenance, in order to avoid risks of electric shock, fire or even death.



**DANGER!
CORROSIVE
MATERIAL**

If pumping hazardous or toxic fluids, the system must be flushed prior to performing service.



**DANGER!
MACHINE IN
OPERATION**

Failure to disconnect electrical power or engine drive before attempting maintenance can cause severe personal injury or death.



**DANGER!
DO NOT REMOVE
SAFETY DEVICES**

Operation without guards in place can cause serious personal injury, major property damage, or death.



**FORBIDDEN
CLEANING AND
MAINTAIN DURING
OPERATION**

Disconnecting fluid or pressure containment components during pump operation can cause serious personal injury, death or major property damage.



**FORBIDDEN
CLEANING AND
MAINTAIN DURING
OPERATION**

Failure to relief system pressure prior to performing pump service or maintenance can cause personal injury or property damage.



Maintenance shall be performed by qualified technicians only, following the appropriate procedures and warnings as presented in this manual.

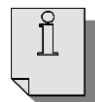

Numbers mentioned in the following subsections correspond to the pump's part list drawing.

9.1 Bearing lubrication



ATTENTION! To avoid possible entanglement of moving parts do not lubricate pump bearings, hydraulic adapter coupling of any other parts while the pump is operating.

Lubricate the bearings every three months at a minimum.

Grease specifications:	Calcium		Lithium	
CHARACTERISTIC	NLGI-3	NLGI-2	NLGI-3	NLGI-00
DISCERNMENT	220-250	265-295	220-250	355-430
DROP POINT °C MIN	95	95	180	160
SOAP LEVEL	13%	13%	13%	
WORKING TEMPERATURE	-10 °C to +95 °C	-10 °C to +95 °C	-25 °C to +120 °C	-25 °C to +120 °C
COLOR	Yellow	Green	Yellow	Green

Table 2: Grease specifications

- Daily check of the pump bearings for excessive noise.
- Daily check of the gaskets for possible leaks.
- Apply grease to the greasers (2) on bearing covers (1) and (34) when applicable.



Do not over grease pump bearings. Excessive grease can cause seal failure.

9.2 Pipe fitting lubrication

At least every three months.

CLEANING

9.3 Cleaning after use

1. To clean the pump, leave the outlet open and the inlet closed.
2. Run cleaning fluid and operate for 1 minute.
3. To remove fluid follow step 1.

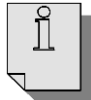

After flushing the pump some residual fluid will remain in the pump and piping.



Properly dispose of all waste fluids in accordance with the appropriate codes and regulations and don't infect the environment.

9.4 Cleaning of the relief valve (bypass)

1. First of all, remove the screws (13).
2. Remove the cover (25).
3. Remove the valve with the cover.
4. Follow the reverse procedure for the replacement.



ATTENTION! Wrong installation of the spring can cause serious injury or even death.

9.5 Strainers

Strainers must be cleaned regularly to avoid pump cavitation. Strainer cleaning is performed according to the instructions of the manufacturer and the conditions of use.



For each filter consult the technical characteristics of the manufacturer about maintenance.

SERVICE PACKS OF PUMPS 4" & 3"

9.6 Gear replacement

To perform service pack 1, follow the procedure below:

1. Remove the screws (17) and the cotter pins (7).
2. Remove front head (29).
3. Remove gears (9) and (26).
4. Replace the gasket (13).
5. Perform reversed procedure for assembly.

9.7 Gear – lip seal replacement

To perform service pack 2, follow the procedure below:

Follow the same procedure until step 4 for gear replacement and:

1. Remove screws (35/30) and bearing covers (1) and (34).
2. To remove lip seals, you first have to remove ball bearings (4) with an extraction tool.
3. To replace lip seals (6) put a screw to the setting place of the bearing covers and push out.

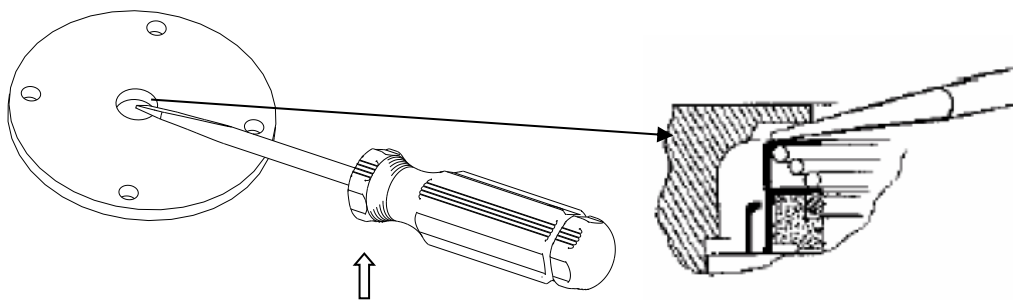

Picture 4: Cover removal



Lip seals have to be replaced every 5000 h of pump operation.

9.8 Replacement of gear - lip seals - bearings

To perform service pack 3, follow the procedure below:

Same procedure as for the replacement of the gear–lip seals and:

1. For the bearing (4) removal before the lip seals (6) removal, remove the bearing with an extraction tool.



Bearings have to be replaced every 5000 h of pump operation.



ATTENTION! When a part of the pump sealed with o-ring is removed, **always** replace the o-ring.



If pump body has internal corrugations the pump should return to the manufacturer for repair.

SERVICE PACKS OF PUMP 1.5''

9.9 Replacement of gears

To perform service pack 1, follow the procedure below:

1. Remove screws (6).
2. Remove heads (28) and (23).
3. Remove gears (9) and (24).
4. Perform reversed procedure for assembly.

9.10 Replacement of seal

To perform service pack 2, follow the procedure below:

1. Remove screws (6).
2. Remove lip seals (5).
3. Perform reversed procedure for assembly.

9.11 Replacement of bearings

To perform service pack 3, follow the procedure below:

1. Remove screws (6).
2. Remove cover (1).
3. Remove bearing (4) with an extraction tool and replace.
4. Perform reversed procedure for assembly.

SERVICE PACKS OF PUMPS 1.25'' & 1''

9.12 Replacement of gears

To perform service pack 1, follow the procedure below:

1. Remove screws (11).
2. Remove gears (7) and (13)
3. Perform reversed procedure for assembly.

9.13 Replacement of seal

To perform service pack 2, follow the procedure below:

1. Remove screws (11).
2. Remove retaining ring (1).
3. Replace seal (3).
4. Perform reversed procedure for assembly.

10. TRANSPORT / STORAGE

Pumps do not need special transport conditions. They have to be protected from strokes.



ATTENTION! Always select the appropriate means for lifting and moving the pump according to its weight. These actions must be carried out by trained personnel.

About storage, they must not be stored in a wet environment because there is danger of corrosion.



If the pump is stored for a long time and stays for a long time out of operation, anti-corrosive fluid is recommended to be used in the pump's chamber.



When the pump's lifecycle is over, it is recommended to refer to a recycling company.



RECYCLING

11. TROUBLESHOOTING

Malfunction	Possible cause	Actions
Pump not running	<ol style="list-style-type: none"> 1. Pump not wet. 2. Worn gears. 3. Inlet closed. 4. Air leaks in the suction line. 5. Strainer clogged. 6. Inlet line or valves clogged. 7. Pump speed too low for priming. 8. By-pass valve partially open, worn or not sealed properly. 	<p>Inspection of the pump and the piping system. Please consult supplier of the pump.</p>
Reduced performance	<ol style="list-style-type: none"> 1. Pump speed too low. 2. Inlet valves not fully open. 3. Air leaks in the inlet line. 4. Damaged or worn parts. 5. By-pass valve set too low. 	<p>Inspection of the pump and the piping system. Please consult supplier of the pump.</p>
Noise	<ol style="list-style-type: none"> 1. Cavitation. 2. Inlet valves not fully open. 3. Inlet line or valves clogged. 4. Excessive pressure loss of the piping system. 5. Operation for a long period with the outlet closed. 6. Inappropriate mounting of the pump. 7. Worn or damaged bearings. 8. Vibrations from improperly anchored piping. 9. Pump – rotor misalignment. 10. Inappropriate operation of the rotor. 11. By-pass valve setting too low. 	<p>Terminate operation of the pump. Inspection of the pump and the piping system. Please consult supplier of the pump.</p>
Damaged gears	<ol style="list-style-type: none"> 1. Solids entering the pump. 2. Running the pump dry for extended periods of time. 3. Cavitation. 4. Viscosity too high for the gears and / or the pump speed. 5. Incompatibility with the liquids pumped. 6. Over-heating. 	<p>Terminate operation of the pump. Inspection of the pump and the piping system. Please consult supplier of the pump.</p>
Broken shaft	<ol style="list-style-type: none"> 1. Shaft misalignment. 2. Viscosity too high for the pump speed. 3. Solids entering the pump. 4. Solids entering the pump. 5. Running the pump dry for extended periods of time. 6. Cavitation. 7. Incompatibility with the liquids pumped. 8. Over-heating. 	<p>Terminate operation of the pump. Please consult supplier of the pump.</p>
Mechanical seal leakage	<ol style="list-style-type: none"> 1. Incompatible fluid (mechanical seal corrosion). 2. Ball bearings over-greased. 3. O-rings not replaced after opening. 4. System over-pressure. 5. High rotating speed. 6. Over-heating. 	<p>Terminate operation of the pump. Please consult supplier of the pump.</p>

Copyright EMHKAM, 2022.

All rights reserved.

Copying, even in parts, is permitted only with the approval of company
EMHKAM.